



II
How a Fish Hunting Snail
Captures its Prey

Each *Conus* species
has more than
one hundred peptides
in its venom



Prialt
(ω -conotoxin MVIIA)
is one of the ~100
components of
Conus magus venom



500-700 Different *Conus* Species

Arguably the largest genus
of marine invertebrates

500-700 Different *Conus* Species

Arguably the largest genus
of marine invertebrates

The venom of each different *Conus* species
has a different set of peptides

500-700 Different *Conus* Species

Arguably the largest genus
of marine invertebrates

The venom of each different *Conus* species
has a different set of peptides

**With 500-700 *Conus* species that each
have ~100 peptides, there are over
50,000 pharmacologically active peptides**

What does the cone snail do with
100-200 different venom peptides?

One obvious answer:

Capture prey



Conus purpurascens











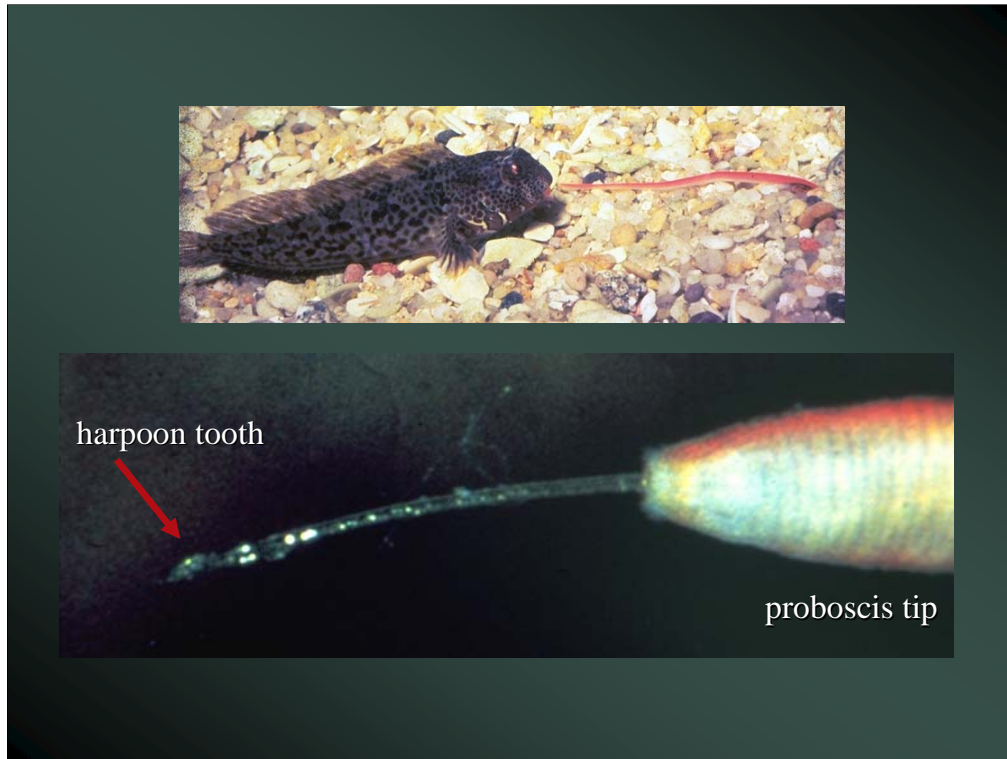



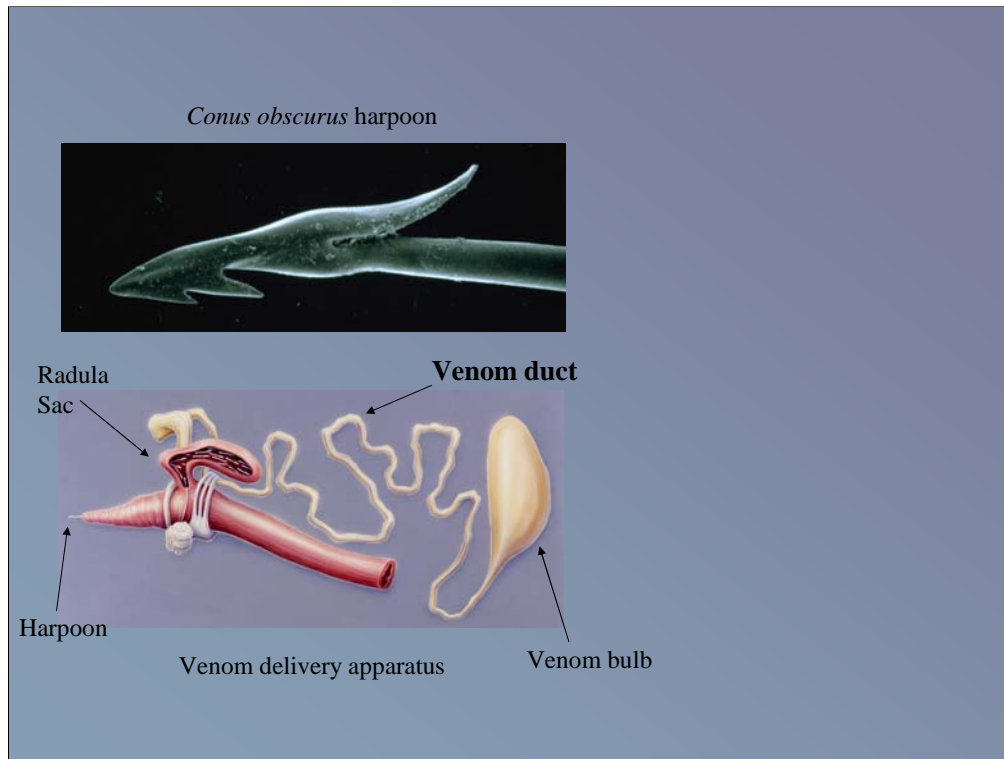

Paralytic Toxins from a single venom

CK SOGSS CS OTS YNCC RS C NOYTYRCY	ω
CK SOGTO CS RGMR DCCT S CLLY SNK CRRY	ω
ECC NPACGRHY SC	α
ECCH PACGKH FSC	α
RD CC TOOK KCK DRQ CKOQRCCA	μ

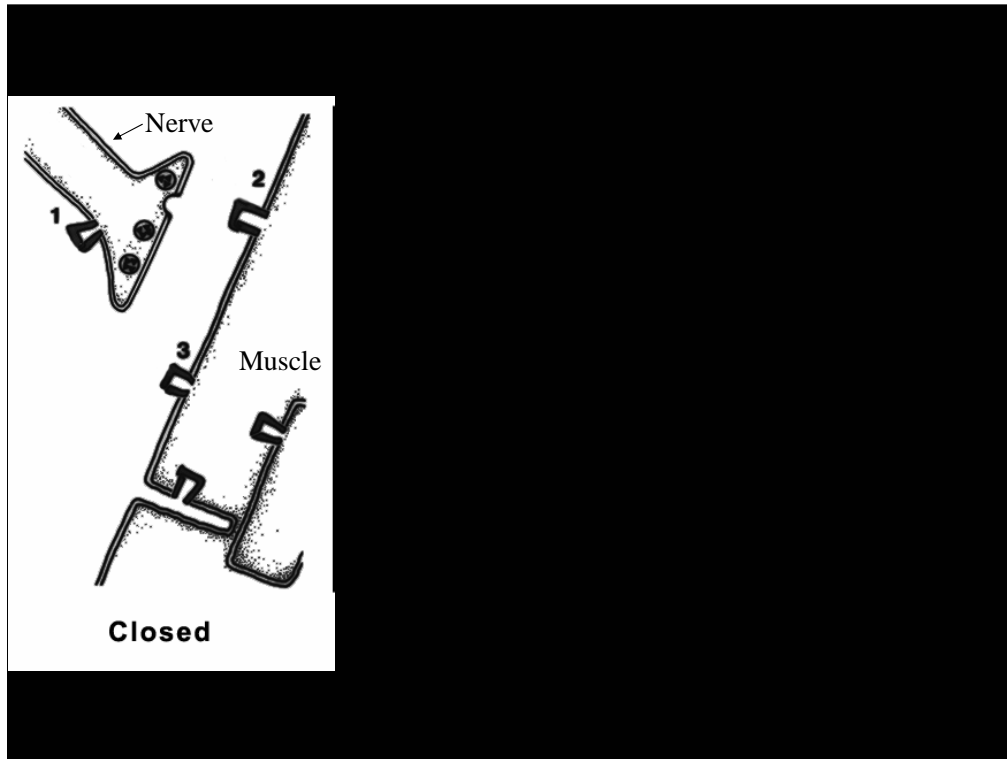

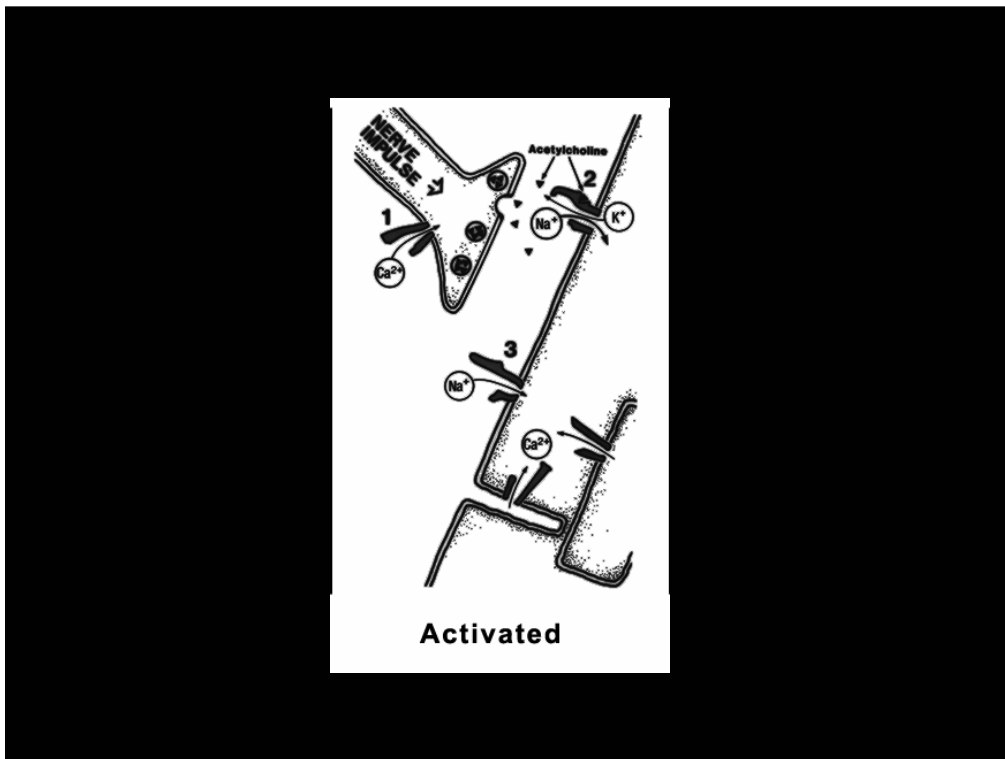

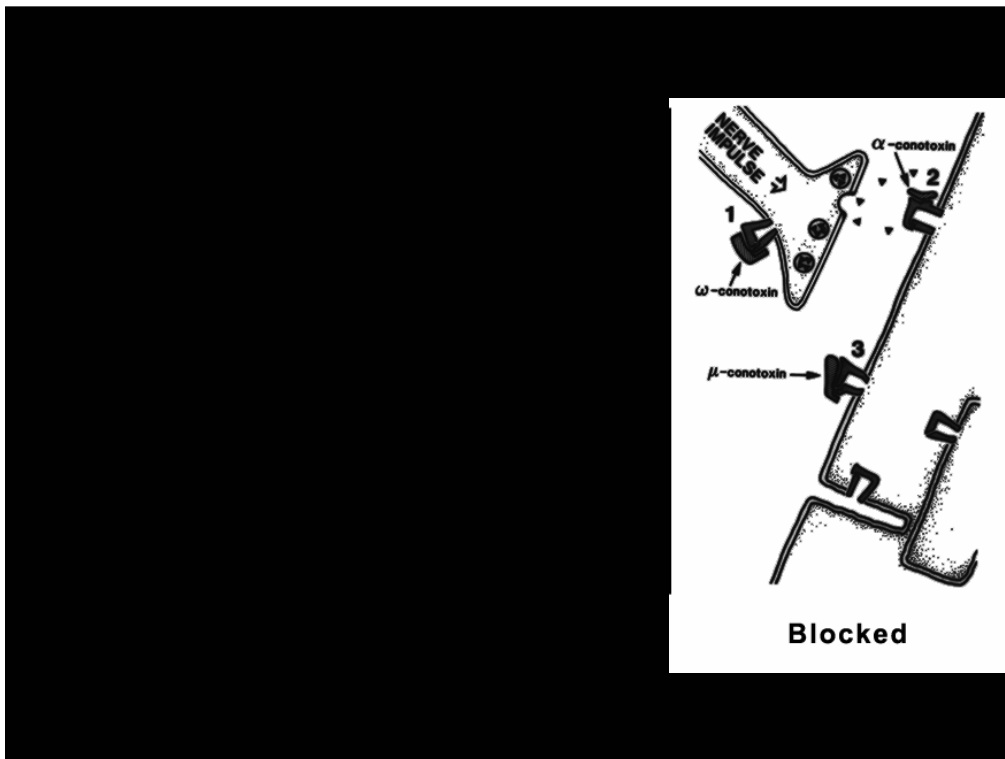

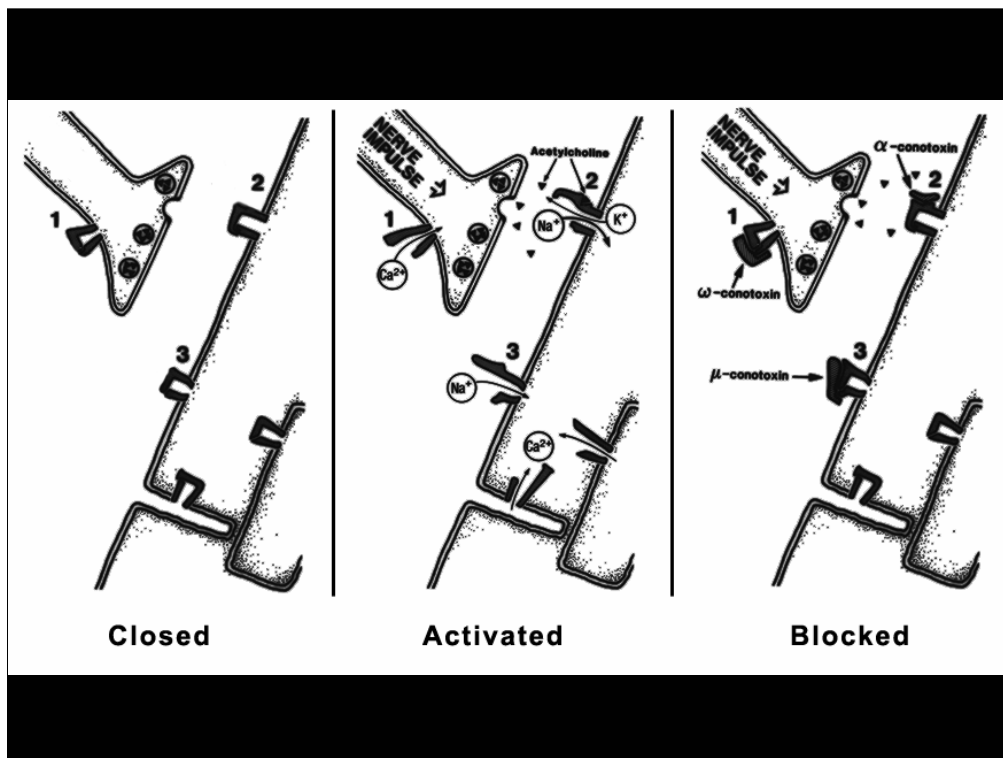

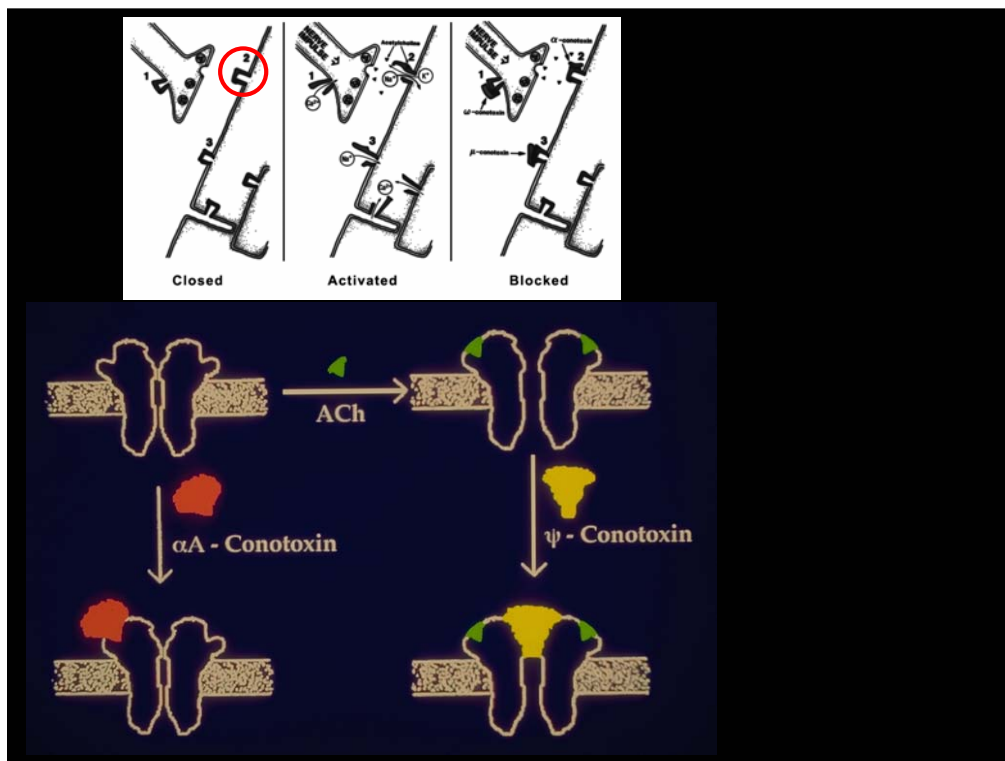

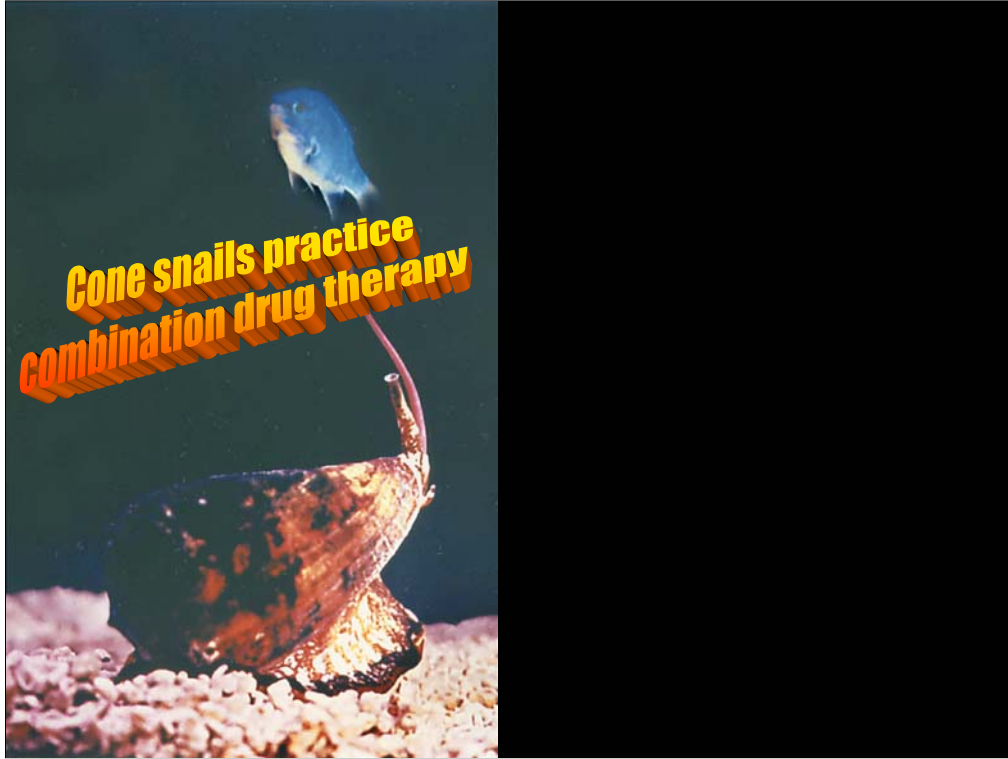

Cabal:

Secret society out to overthrow existing authority

Motor Cabal

Presynaptic Ca Channel	(ω -Conotoxin)
Nicotinic Acetylcholine Receptor	
ACh Binding Site	(α -Conotoxin)
Ion Channel	(ψ -Conotoxin)
Muscle Na Channel	(μ -Conotoxin)



Cone snail immobilizes fish in ~2 seconds
Motor cabal takes >10 times longer

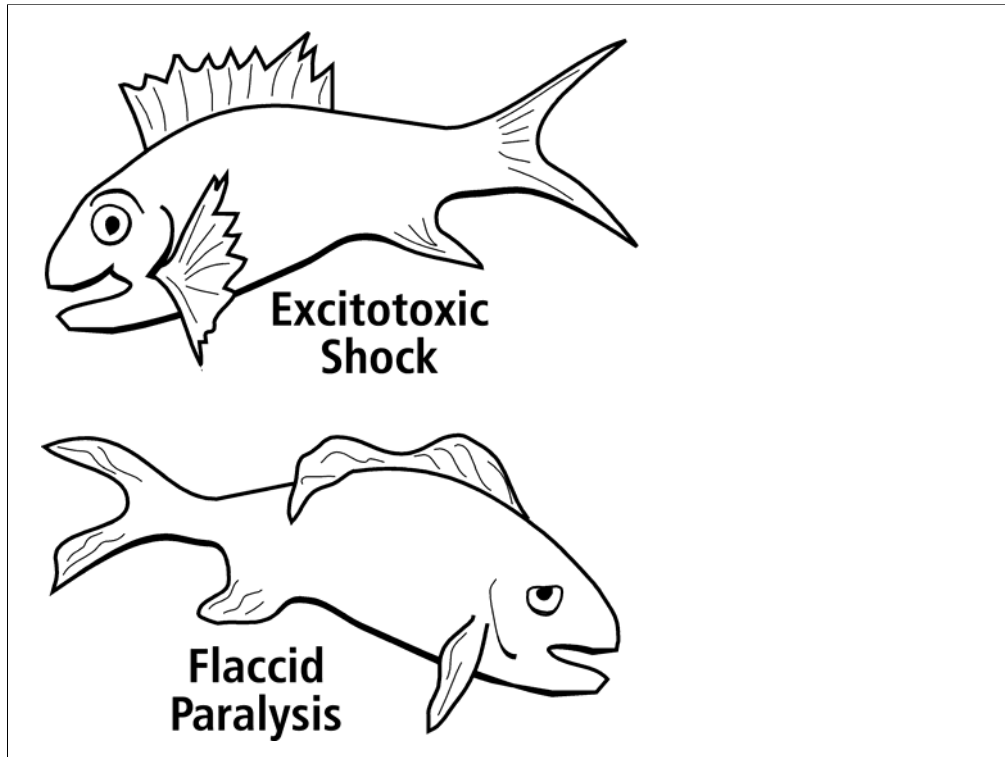

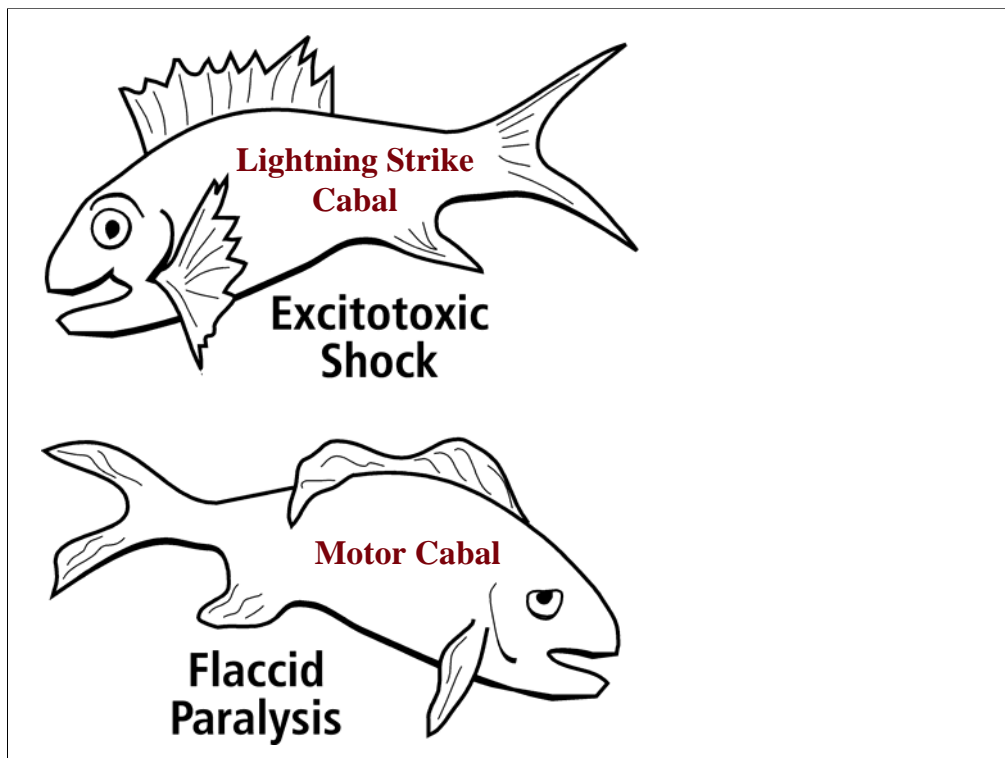

Lightning-strike cabal

δ -Conotoxin - **INCREASES Na channel conductance**

κ -Conotoxin - Blocks K channels

Others - ?



(K. J. Shon, M. Grilley, H. Terlau)

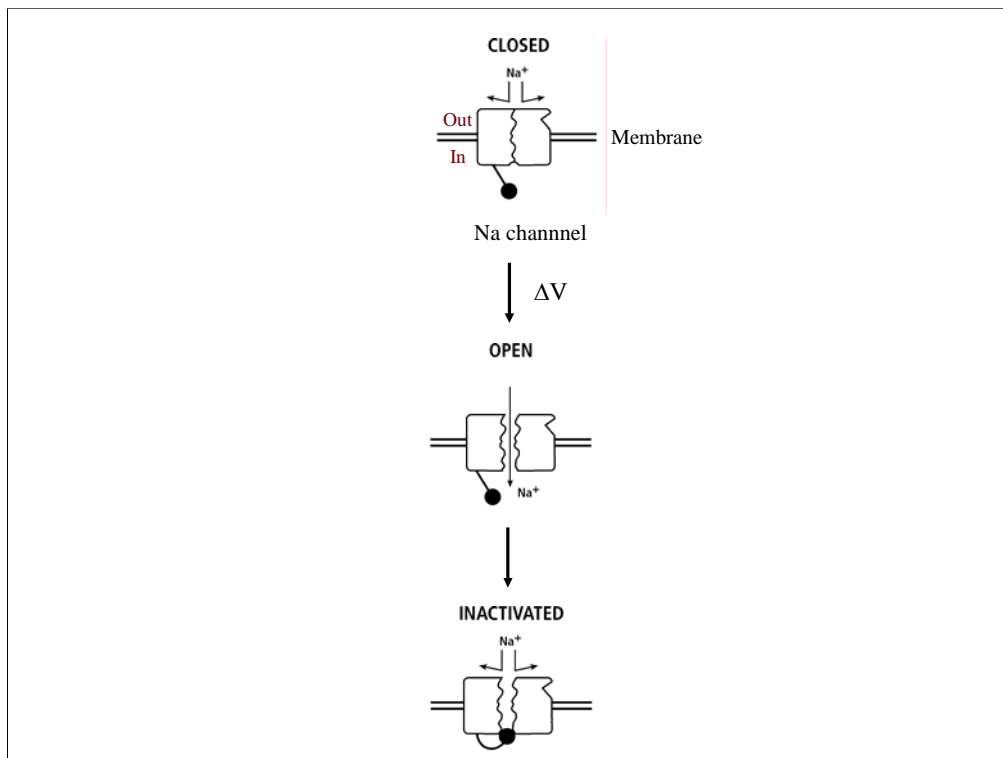

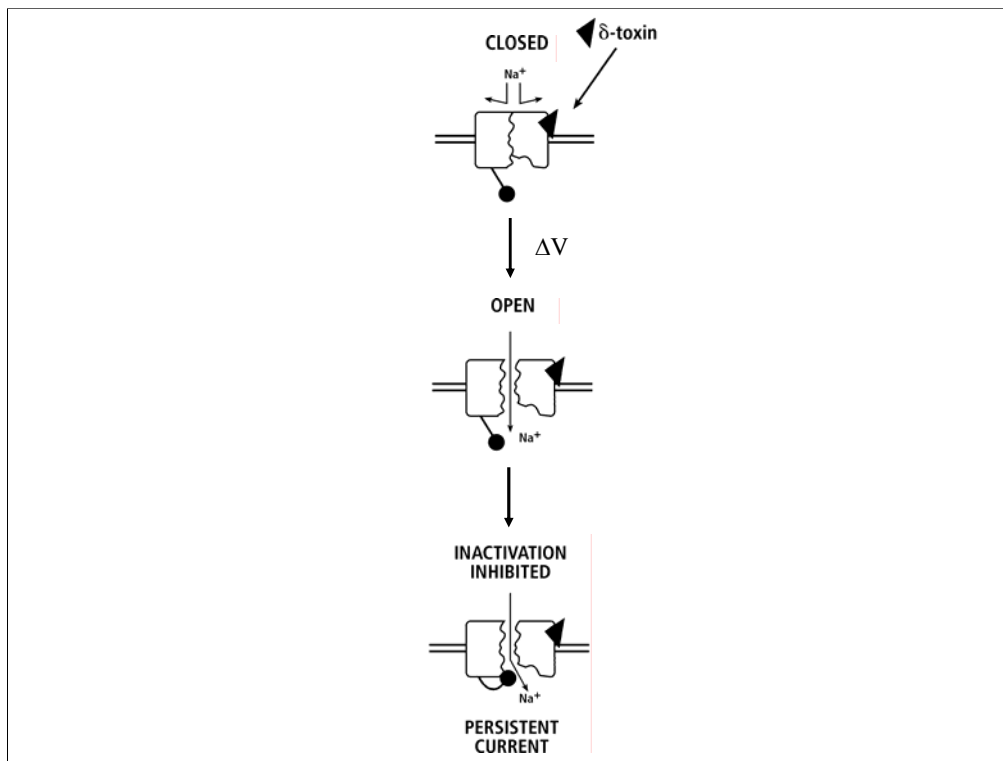

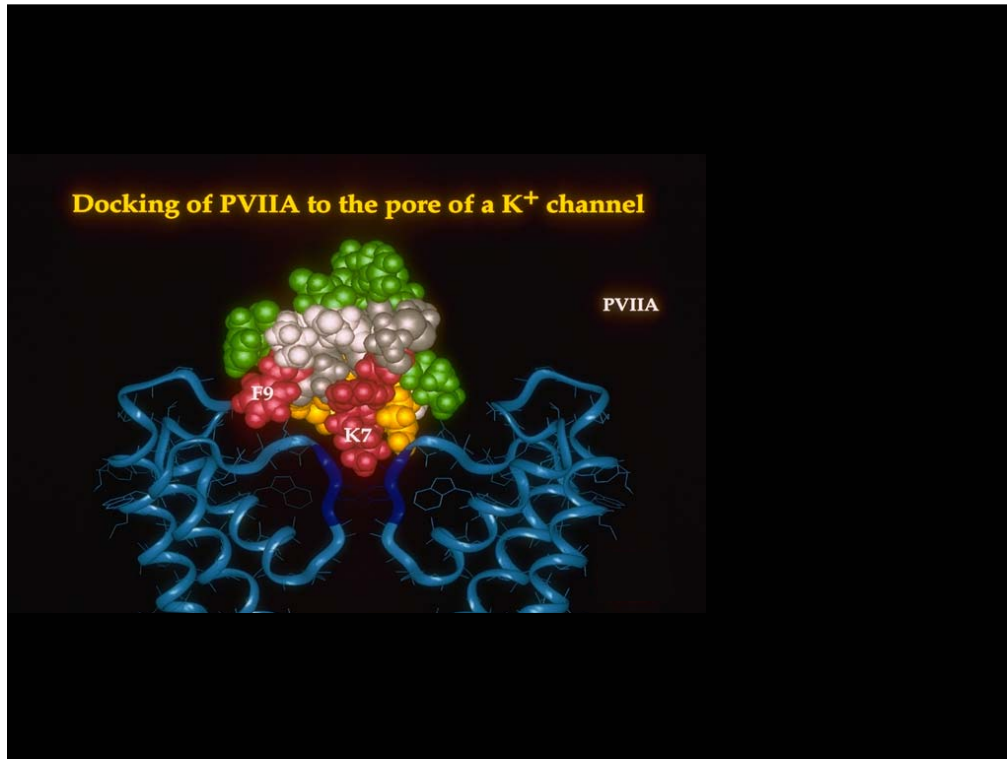

Effects of Lightning Strike Cabal

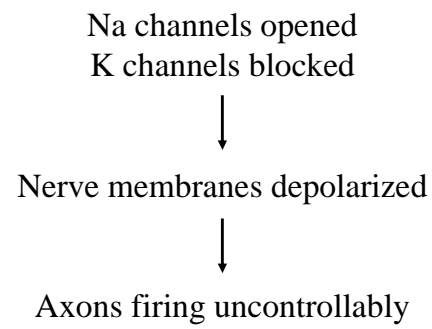

Prey Capture

1 Excitotoxic Shock

Very rapid, fish stunned

2 Neuromuscular Block

Irreversible paralysis

Lightning-strike cabal

- | | | |
|-------------|---|---|
| δ-Conotoxin | - | INCREASES Na channel conductance |
| κ-Conotoxin | - | Blocks K channels |
| Others | - | ? |

Motor cabal

- | | | |
|-------------|---|--|
| ω-Conotoxin | - | Blocks Ca channels |
| α-Conotoxin | - | Competitive nicotinic receptor inhibitor |
| ψ-Conotoxin | - | Nicotinic receptor channel blocker? |
| μ-Conotoxin | - | BLOCKS Na channel conductance |

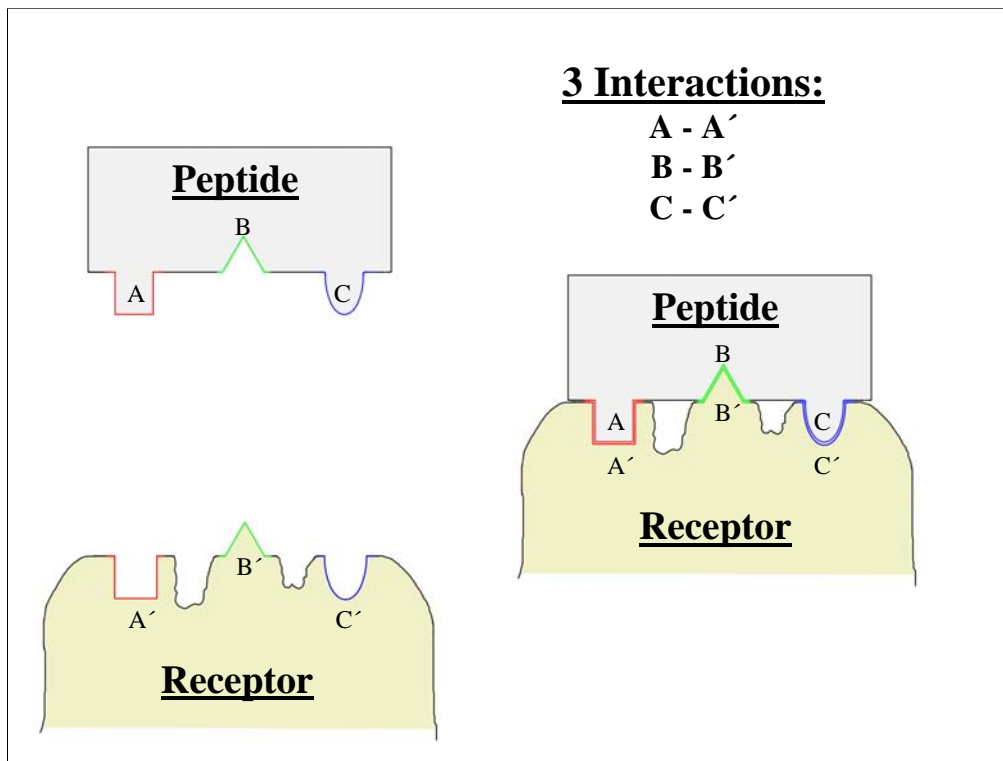

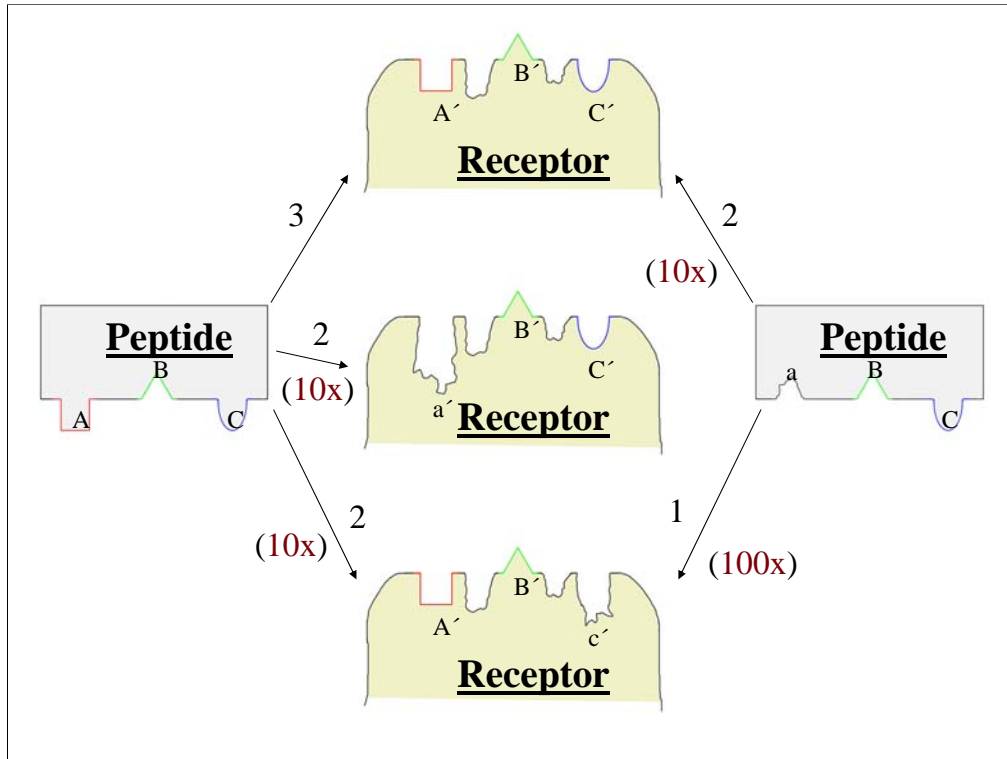

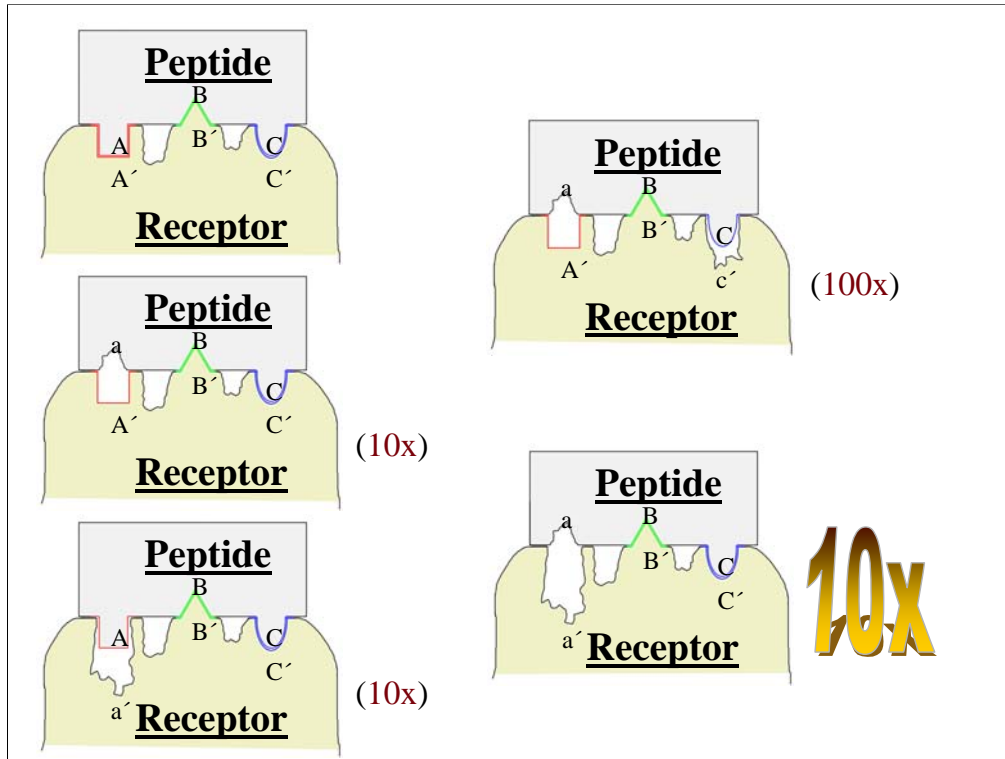

κ-PVIIA

